



Pumps for hygienic use

The complete line





Alfa Laval is one of the world's largest pump suppliers, offering a flexible portfolio of centrifugal pumps, liquid ring pumps and positive pumps.

Our portfolio is the result of a combination of comprehensive pump knowledge and the highest standards of hygiene, trouble-free operation and a truly low cost of ownership.

Performance in good hands

Working with hygienic applications is a question of care, attention to detail and dedication to outstanding performance. Alfa Laval has a proven track record in delivering innovative solutions for hygienic applications based on our core technologies of separation, heat transfer and fluid handling.

Superior safety, gentle efficiency and uncompromising cleanliness are the hallmarks of our hygienic pumps, heat exchangers, valves and automation, tubes and fittings, and separation, filtration and tank equipment. Which is why so many customers in the food, biopharm and other demanding industries put process performance and hygiene in the capable hands of our experts, sales companies and partners worldwide.

Here you will find an overview of Alfa Laval pumps for hygienic applications. For complete technical details and product specification, contact your local Alfa Laval supplier or visit us at **www.alfalaval.com**



Gentle product treatment

Our centrifugal pumps are renowned for their ability to move products gently and efficiently. The integrity of your product is assured, regardless whether you choose a premium or standard-duty model.

Advanced hygienic design

With emphasis on features such as optimized internal geometry and profiled o-rings, our centrifugal pumps are suitable for CIP (cleaning-in-place) and offer exceptional levels of hygiene. All have been tested in accordance with EHEDG requirements and many are authorized to carry the 3-A symbol.

Advanced seal design

Many of our pumps share the same mechanical shaft seal, which simplifies maintenance and spare parts inventory. Combined with the quick and easy front-loading design, this reduces maintenance costs, increases uptime and reduces the cost of ownership.

Easy seal conversion

The external design of our centrifugal pumps, as well as the seal's construction, is designed to make seal conversion as fast and as simple as possible. Our premium LKH pumps can be converted from single to flushed or double-mechanical seals, while our standard-duty SolidC pumps can be converted from single to flushed shaft seals.

Centrifugal pumps

Alfa Laval's centrifugal pumps are built to perform in all areas – from process quality to overall energy efficiency. In addition to gentle product handling and a wide range of hygienic features, they provide a long and trouble-free service life that ensures low cost of ownership.

Our centrifugal pump series can be divided into two categories, premium and standard-duty.

The first category comprises our various cost-effective LKH pumps, which handle specialized needs such as evaporation, high-pressure, self-priming and high-purity applications. The second focuses on initial cost, which includes our optimized SolidC pump series.

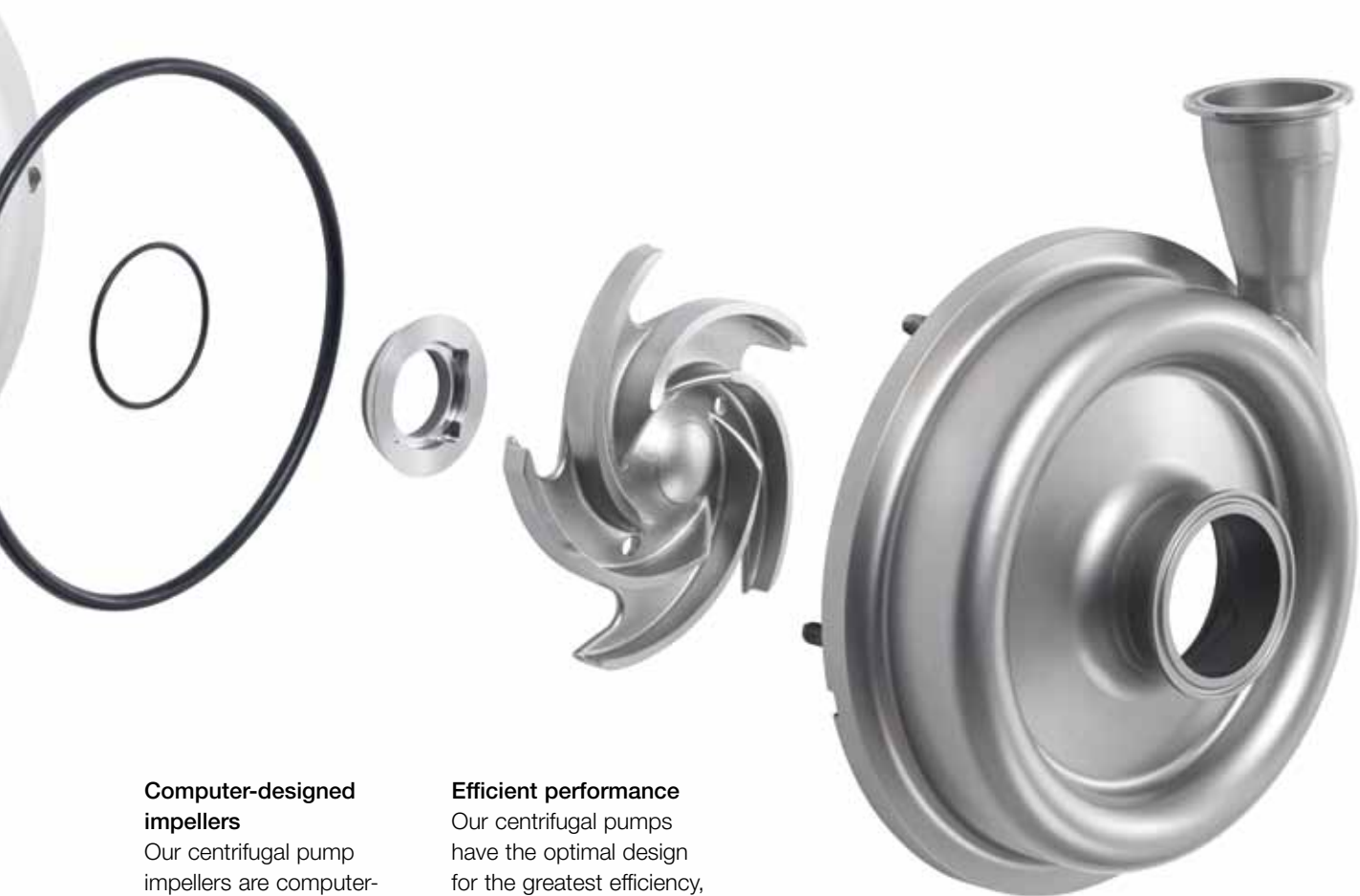

Computer-designed impellers

Our centrifugal pump impellers are computer-designed and hydraulically balanced for optimum performance. Both the impellers and their retaining screws (optional) are smooth, which keeps them from accumulating product and makes cleaning more effective.

Efficient performance

Our centrifugal pumps have the optimal design for the greatest efficiency, lowest NPSH requirement and low noise levels. This reduces energy cost, lowers the risk of cavitation and provides a safe working environment, which enables efficient capitalization of the process.

Premium pumps

Quiet but rugged, Alfa Laval's LKH series of centrifugal pumps are the ultimate solution for gentle and efficient product handling. Through a combination of enlarged inlets and advanced impeller design, they offer an unobstructed product flow, very low NPSH requirements and superior hydraulic efficiency.

Designed for CIP (cleaning-in-place), LKH pumps are available in capacities of up to 500 m³/h and pressures of up to 190 m (19 bar), with different versions available for specific applications.

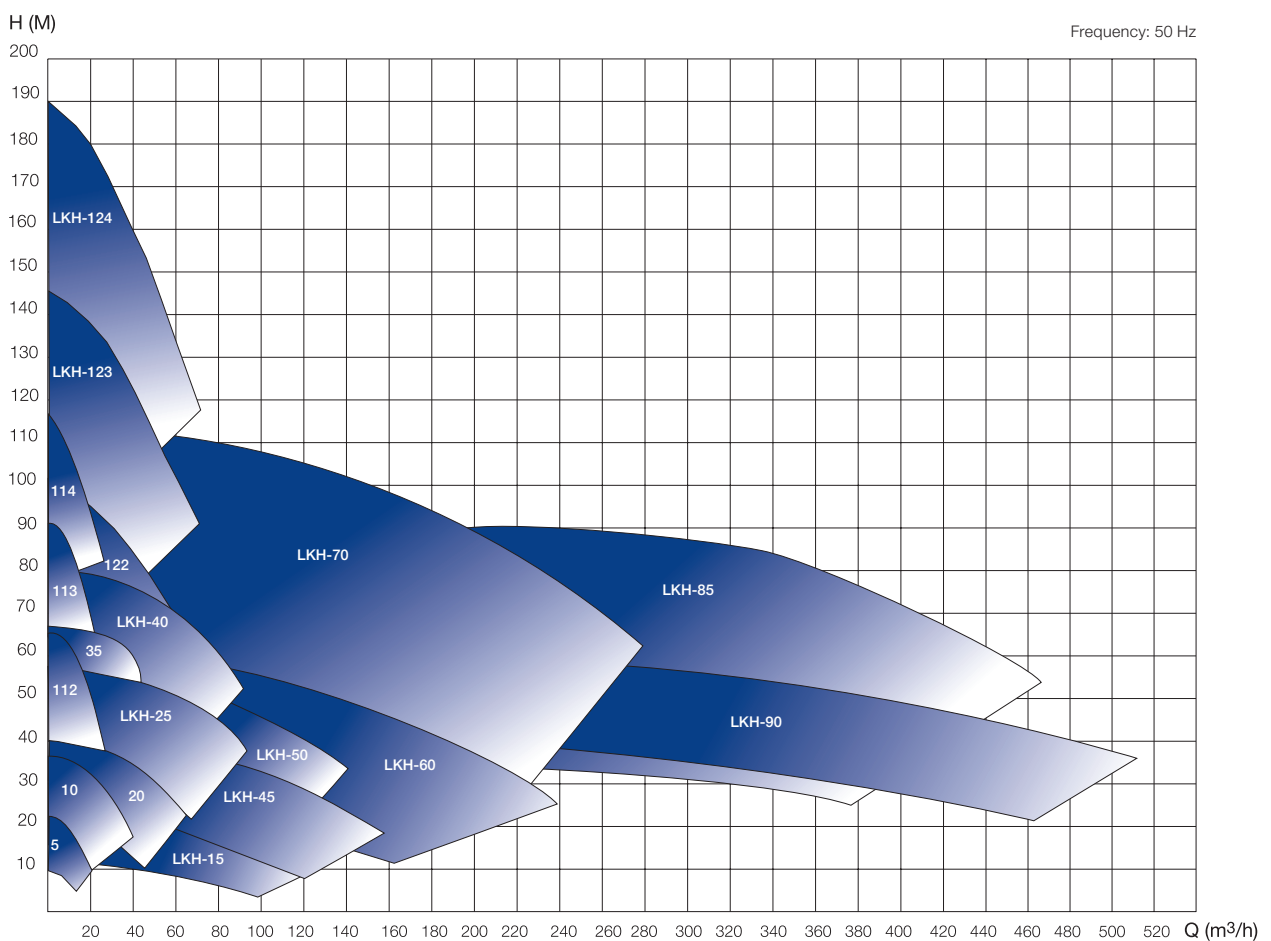

LKH performance: LKH pumps are available for capacities up to 500 m³/h and pressures up to 190 m (19 bar).

LKH

The LKH is a highly efficient and economical centrifugal pump range, which meets the requirements of sanitary processes for gentle product treatment, hygiene and chemical resistance. Its front-loaded design makes quick, effective maintenance possible, thereby contributing to more production time and low cost of ownership. Available in 13 sizes, the LKH features efficient drives which make it possible to optimize performance for the selected duty as well as comply with 3-A, CE and EHEDG requirements.



LKH UltraPure

LKH UltraPure pumps are high-purity pumps that meet specifications for water-for-injection (WFI) and other demanding applications. Authorized to carry the 3-A symbol, they are suitable for both CIP (cleaning-in-place), SIP (sterilization-in-place) and manual cleaning. LKH UltraPure pumps are also available with a 0.5 μm (150 grit) finish, flushed seal kit and a comprehensive Q-doc documentation package to smooth the qualification and validation process.

LKHex

Highly efficient and economical, the LKHex centrifugal pump meets the requirements of the ATEX directive 94/9 IEC group II, categories 2G and 3G with temperature classes T1~T4.



LKHI

An extension of the LKH range, the LKHI has an internal seal for use in applications that require higher inlet pressures of up to 16 bar. The simple, effective design is well suited, although not limited to, filtration-type applications and combines reliable and efficient operation with ease of maintenance.



LKH Multistage

Designed to 3-A standards and available in two-, three- or four-stage models, LKH Multistage pumps save space and energy by replacing up to three booster pumps in a line. Used primarily in high-pressure applications with low capacity, they withstand system pressures up to 40 bar and deliver boost pressures up to 19 bar. This makes them suitable for, but not limited to, many types of filtration applications.



LKHPF High Pressure

Pumps in the LKHPF High Pressure series feature a reinforced pump casing and backplate, as well as high pressure internal seals and multiple heavy-duty studs. This enables them to handle inlet pressures as high as 40 bar, making them ideal for nanofiltration and reverse osmosis filtration. Their seals can be removed in a matter of seconds, without removal of the back plate.





LKHSP

Pumps in the LKHSP series are self-priming, which means they can be used to pump products containing air or gas. This makes them ideal as return pumps in CIP (cleaning-in-place) systems, as well as for emptying tanks. LKHSP pumps feature a tank, a non-return valve (normally closed) on the inlet side, a tee and a non-return valve (normally open) on the bypass line.

LKH Evap

LKH Evap are sanitary pumps with high efficiency and the lowest NPSH requirements, making them ideal for use in evaporation applications, such as liquid concentration and powder processing solutions, as well as in dewatering plants. Using the optional clear flow impeller design, process optimization can be achieved in applications where there is a risk of hard layer deposits.



Maximum shaft seal interchangeability for pump ranges. Front-loaded design.

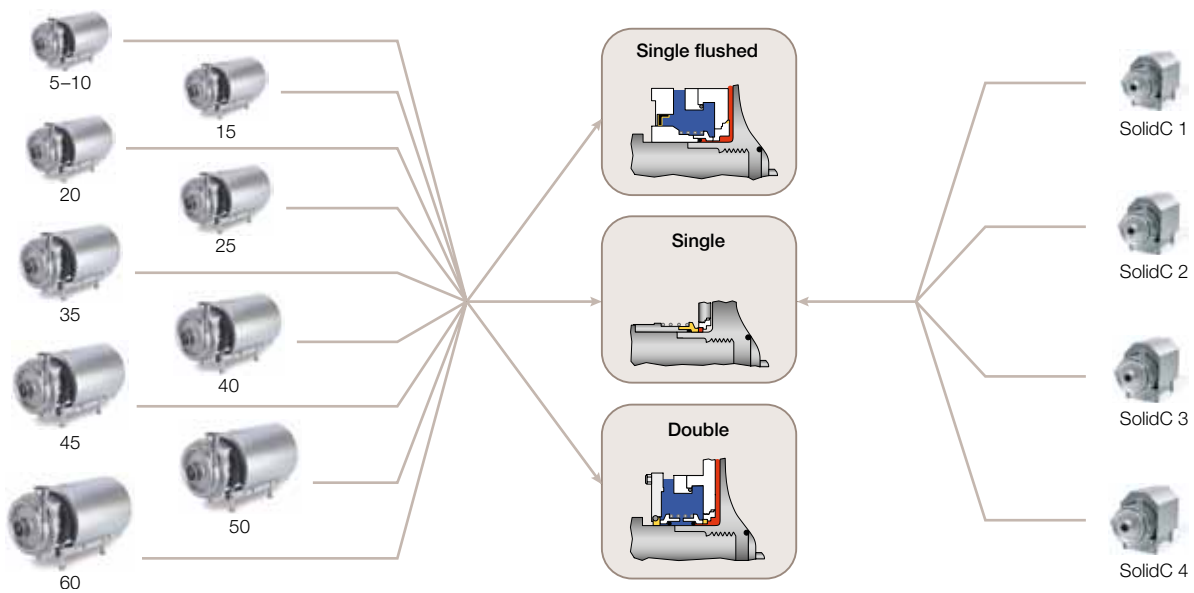

Identical shaft seal for easy maintenance and flexibility. Only one size of shaft seal is required for all LKH standard models (LKH 5–60) and SolidC (SolidC 1–4), which makes keeping the right parts in inventory simple and inexpensive. Plus, a single mechanical seal can easily be changed to a flushed or double mechanical seal in minutes with just a few extra components.

Standard-duty pumps

Alfa Laval's standard-duty centrifugal pumps are designed to offer high value for money. In addition to gentle product handling and efficient operation, they offer high reliability and possibilities for swift and easy maintenance.

The highlight of our standard-duty pumps is the SolidC series, which combines a practical, cost-effective design with certain characteristics of our premium LKH centrifugal pumps.



SolidC

The SolidC pump series is a reliable and cost-effective solution for simple transport duties up to 85 m³/h. It utilizes the same mechanical shaft seal found in our LKH series, which is front-loaded and easily replaced without removing the backplate. SolidC pumps are available in four sizes and comply with 3-A, CE and EHEDG requirements.

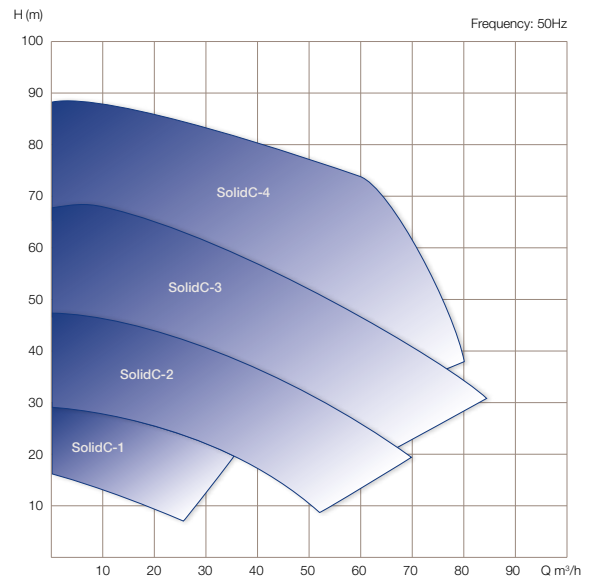

SolidC performance: SolidC is a reliable, cost-effective centrifugal pump for standard duties up to 85 m³/h.

SolidC UltraPure

This reliable and economical centrifugal pump meets the requirements of the biopharm industries. It has a 0.5 µm (150 grit) finish, 3.1 material certification, gentle product treatment and chemically resistant material suitable for a wide range of duties. Our comprehensive Q-doc documentation package supports a smooth qualification and validation process, which provides solid value for money.



FM-OS and GM centrifugal pumps

The FM-OS and GM centrifugal pumps series are economical alternatives for industries in which acid-resistant steel is required. Specifically designed to handle specific applications at low capacities, these centrifugal pumps are solid, cost-effective solutions for handling acidic products.



Liquid ring pumps

Liquid ring pumps are an ideal solution when gases are contained in the process medium. Because the pumps are self-priming when the casing is half filled with fluid, they are capable of pumping from a suction line that is partly filled with air or other gases.

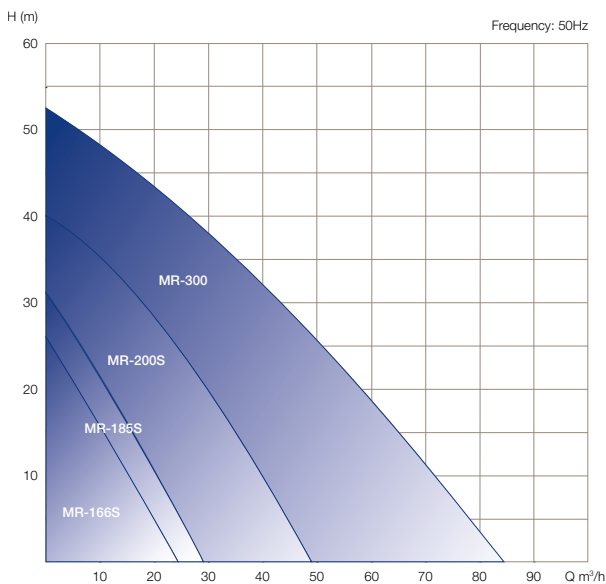

MR liquid ring pumps are reliable and cost-effective for standard duties up to 84 m³/h.

MR liquid ring

Through the simplicity of its design and service reliability, the MR liquid ring pump series is a cost-effective solution for products containing air or gas. These pumps are specifically developed for use in food, chemical and pharmaceutical industries, where they are often used as return pumps in CIP (cleaning-in-place) systems. MR liquid ring pumps are available in four sizes with duties up to 84 m³/hr to fully optimize your process requirements.

Positive pumps

Designed for low, medium and high-viscosity media, Alfa Laval positive pumps offer gentle pumping action and reliable performance which results from more than 50 years of continuous development at advanced production and R&D facilities.

Our positive pump portfolio includes four ranges: SX, SRU, OptiLobe and SCPP.

With its robust construction, each pump is developed for a different type of demand and meets high standards of quality and reliability. Collectively, they provide operating economy and high flexibility of use.



Gentle, hygienic design

With their high-precision rotors and low-shear operation, our positive pumps ensure the gentle movement of delicate products. Designed for maximum cleanability, our pumps comply with the world's leading hygienic standards.

Modular pump design

Modular design increases flexibility and component interchangeability, reducing maintenance time and spare parts inventory. The wide range of sizes available enables selection of the most cost-effective solution for your process requirements.

Universal mounting

To provide high flexibility when fitting the pump into a production line, all of our positive pumps can be mounted in either a vertical or horizontal port position.

Improved drainability

All of our positive pumps can be drained easily when mounted in vertical port position. In the case of our OptiLobe and SX pumps, cusps are retained in vertical configurations for greater efficiency.

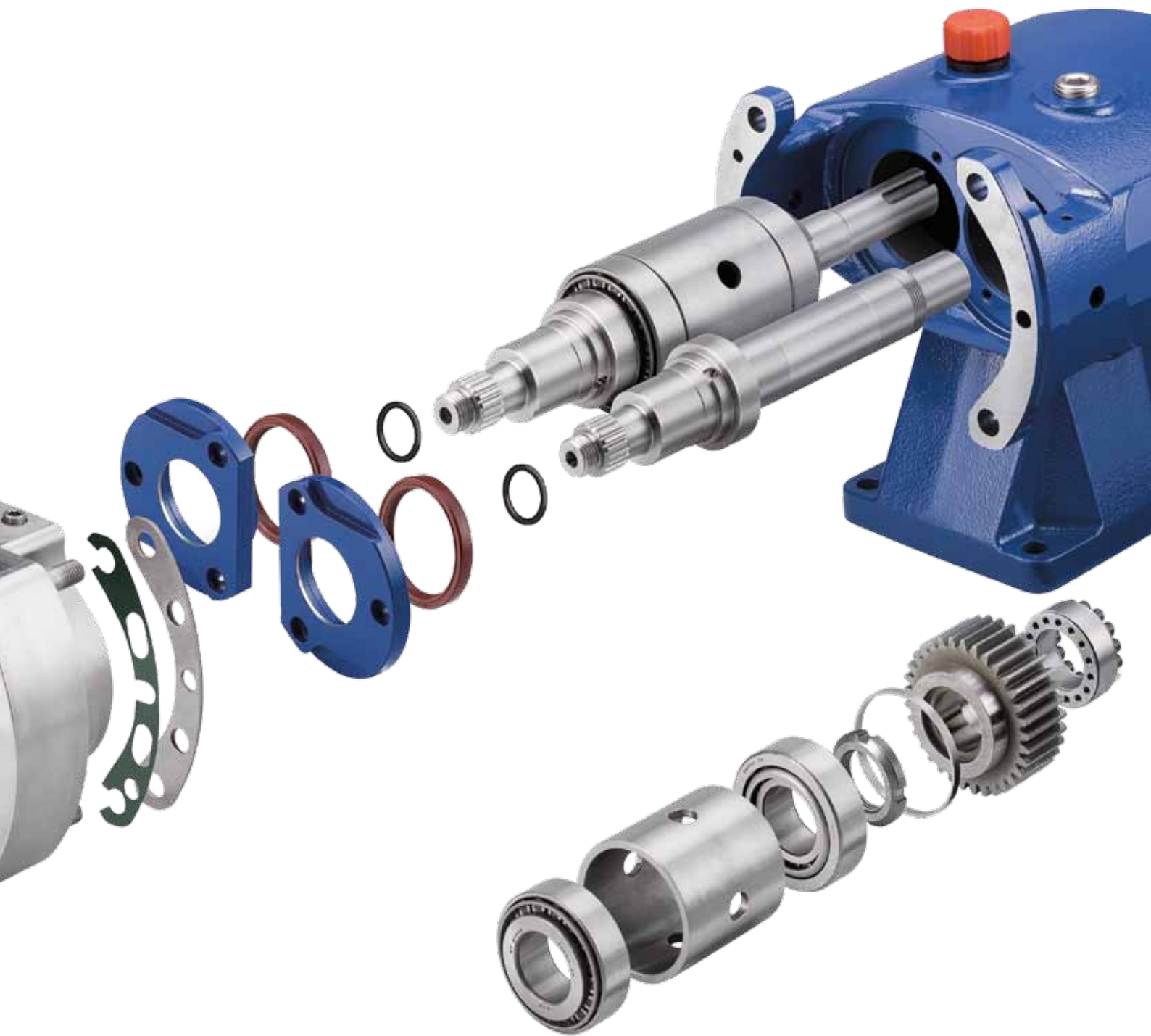

Easy seal retrofit

The seals of our positive pumps are designed for quick and simple up-grading. Our broad range of seals includes many seal types and configurations, which can be tailored to your need and application.

Heavy-duty gearbox construction

These pumps have a cast iron gearbox with heavy-duty taper roller bearings and torque locking assemblies for easy maintenance and high reliability.

CIP and SIP

Our positive pumps are ideal for both CIP (cleaning-in-place) and SIP (sterilization-in-place) applications.

Standards and approvals

All of our positive pumps are compliant with CE directives and the EHEDG, 3-A and FDA hygienic standards. In addition, our SX and SRU pumps can meet ATEX requirements for use in explosive environments.



SX

The SX is Alfa Laval's premium positive pump, is designed for use in sensitive and ultra-clean applications. With optimized pump head geometry and multi-lobe rotors, SX pumps ensure low-shear operation with minimum pulsation. This makes them the best choice for maintaining the integrity of delicate products.

SX pumps feature front-loading mechanical seals, and low-profile rotor nut for the highest level of hygienic sealing and enhancing cleanability. Options available for mechanical and/or electropolishing to achieve higher surface finishes up to 0.5 Ra as well as 3.1 material traceability.

SRU

The SRU is Alfa Laval's core positive pump with extensive options, materials and ability to handle a wide range of temperatures and pressures. This makes it the ideal solution for the most demanding of applications.

Among the many options are saddles and jackets for heating and cooling of the pump head, rectangular inlet for pumping high viscosity fluids and a wide selection of standard seals, including proprietary seals to suit most applications. In addition, you can choose from tri-lobe or bi-lobe rotors depending on the application.



OptiLobe

The OptiLobe is Alfa Laval's standard positive pump intended for general applications. Available in an optimized range with fewer options, OptiLobe pumps combine cost-effective simplicity with Alfa Laval quality and reliability.

OptiLobe pumps feature a paint-free design with front-loading seals and tri-lobe rotors. They are the latest example of Alfa Laval's leadership in innovative design and advanced manufacturing processes.

SCPP

The SCPP is a circumferential piston pump designed for transporting very low viscosity products in applications that require medium to high discharge pressures. The piston design offers low shear with low pulsation and minimizes damage to product and bruising of solids.

Two SCPP ranges are available: the SCPP1 specifically designed for quick and easy strip-clean type processes and the SCPP2 where CIP (cleaning-in-place) may be utilized.



This complete portfolio of positive pumps enables Alfa Laval to offer the most effective solution, whatever the application.

Motorization



Pumps can be supplied as bare shaft for mounting locally in the process line or within a skid. Alternatively, Alfa Laval offers the units fully motorized using robust, reliable and efficient geared drives, which can be designed for direct drive or for speed control.

The rigid base plate ensures accurate alignment of the pump and drive and is available in stainless steel for hygienic environments or painted carbon steel for industrial applications.

Other options include ball feet for raising the unit above the floor level to provide access for cleaning and stainless steel shrouds to protect the drive against dirt entrapment and enable easy wash down.

Everything you need

To tailor pump solutions to individual customer requirements, Alfa Laval has a comprehensive package of effective tools and software programs that help our partners size and configure the right pumps for any given installation – quickly and efficiently.

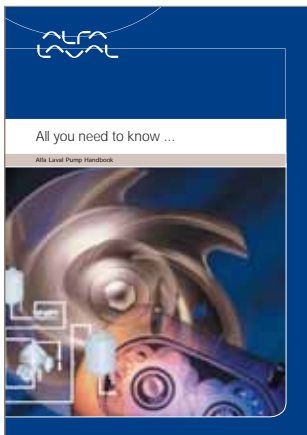

The Alfa Laval pump handbook.

All you need to know

The Alfa Laval pump handbook is a comprehensive reference guide to support pump users at all levels. It includes all the necessary information for the correct selection and successful application of the Alfa Laval range of pumps.

Computer-Aided Selection software

Alfa Laval Computer-Aided Selection (CAS) software helps quickly and easily size hygienic pump installations and identify the pump configuration optimized to your specific process requirements. CAS also includes article numbers and spare parts lists, which makes it easy to compile order lists and streamline maintenance and service procedures. This unique Alfa Laval tool can also help to estimate service costs to assist in budget planning.



Computer-Aided Selection (CAS) software.

Rheology laboratory

Our laboratory provides us with a thorough understanding of individual fluid behaviour, which contributes to the correct sizing of pumps, seal specification as well as optimizing system design. This ensures the selection of the right pump the first time, which potentially reduces both capital investment and life cycle costs.

CAD portal

The Alfa Laval CAD portal offers access to 2D and 3D CAD drawings in a variety of formats, providing ease of design and installation.

Animations and maintenance videos

Effective short animations provide a general overview of the products and a greater understanding of its characteristics and capabilities. In addition, Alfa Laval maintenance videos detail the procedures of timely and effective maintenance to keep processes running efficiently and achieve low life cycle costs.



Maintenance videos.

Comprehensive documentation

We provide you and your suppliers with full documentation and comprehensive installation and maintenance instructions in multiple languages. This makes it easier to keep to installation and maintenance schedules, helps cut operating and maintenance costs and increases plant running time.

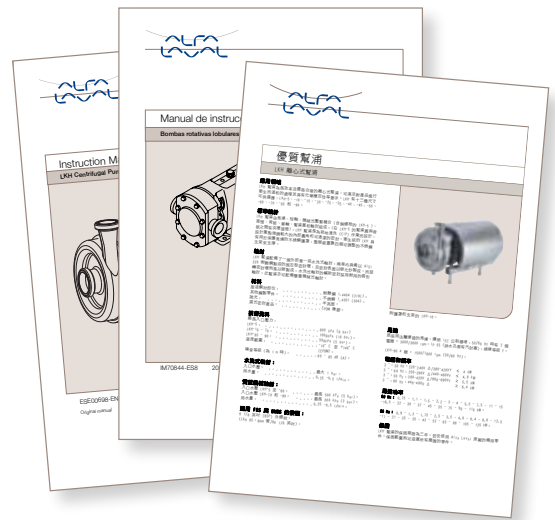

Comprehensive documentation in multiple languages.

Q-doc

All Alfa Laval UltraPure products can be supplied with Q-doc, a comprehensive documentation package based on GDP (Good Documentation Practices). Q-doc comprises equipment manuals, quality and manufacturing procedures, relevant material certificates and necessary parts and service information for standard components. The Q-doc documentation package supports a smooth qualification and validation process.



Q-doc.

Certification and compliance

Alfa Laval pumps generally comply with the latest international standards and legislation to ensure total process safety and the highest quality product. This includes, but is not limited to, the highest standards and requirements in the industry such as the CE machinery directive, 3-A, EHEDG, FDA and ATEX as well as EU Regulation 1935/2004, Article 17 (traceability).

Close at Hand

To make selection of Alfa Laval products easy, there is a comprehensive over 1400-page catalogue entitled "Close at Hand", which includes detailed information on the world's broadest portfolio of hygienic components and provides convenient one-stop shopping.



Close at Hand catalogue.

For more info and access to tools and software

- www.alfalaval.com/biopharm
- www.alfalaval.com/food
- www.alfalaval.com/high

Handling your hygienic processing needs

Optimizing the performance of hygienic processes is a challenge best met with expertise. Alfa Laval expertise is the result of years of accumulated knowledge and a comprehensive research and development programme.

With this foundation, we work closely with our channel partners to help companies extract the most value from raw materials, minimize waste and emissions, and deliver safe and hygienic products. Ultimately, our ambition is to help companies supply quality products to consumers at competitive prices.

Alfa Laval has served as the standard bearer for the production of hygienic products since Gustaf de Laval invented the centrifugal separator to separate cream from milk more than a century ago. That same ingenuity is applied to all our hygienic components and solutions that safeguard the flavour, texture and appearance of food, dairy products, beer and other beverages.

For the pharmaceutical, biopharm and personal care industries, our contributions not only entail hygienic design and superior performance but comprehensive documentation and solutions that are easy to validate. Which in turn raise the quality, cleanliness and uniformity of the final products.

Safeguarding hygienic applications requires entrusting your processes to the safe, competent care of a reliable partner. With Alfa Laval you are in good hands.



Working locally on a global scale

Alfa Laval brings you the advantages of a worldwide organization supported by a strong network of 1,500 partners around the globe. This gives you a one-stop shop for everything, including quality parts and unmatched service expertise.

Trustworthy service

Guaranteed performance, reliability and hygiene come standard with every Alfa Laval pump. Each pump is backed by the service and support from our global organization and local network of distributors, system builders and contractors. This gives you easy access to advanced resources and specialist knowledge about hygienic components and processes.

Investing in quality parts

There are no short cuts to quality, especially when the integrity of hygienic processes is at stake. That is why investing in Alfa Laval hygienic components and solutions ultimately pays off.

Alfa Laval parts are precision-made to ensure optimal performance. Rigorous testing in our materials laboratory under actual operating conditions ensures that each part will uphold safety, efficiency and hygiene of your processes for the long term.

Unsurpassed reliability

It goes without saying that an investment in quality is an investment in reliability. Alfa Laval hygienic components and solutions are designed and sized right from the start. When reinforced by maintenance programmes and Alfa Laval parts, you are able to achieve a strong total cost of ownership and true peace of mind.



Alfa Laval in brief

Alfa Laval is a leading global provider of specialized products and engineered solutions.

Our equipment, systems and services are dedicated to helping customers to optimize the performance of their processes. Time and time again.

We help our customers to heat, cool, separate and transport products such as oil, water, chemicals, beverages, foodstuff, starch and pharmaceuticals.

Our worldwide organization works closely with customers in almost 100 countries to help them stay ahead.

How to contact Alfa Laval

Up-to-date Alfa Laval contact details for all countries are always available on our website at www.alfalaval.com

www.fotoskift.se



ALFA LAVAL is a trademark registered and owned by Alfa Laval Corporate AB.